













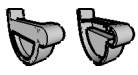





ELEMENTS		REF. 4 ML TKIT162G	REF. 6 ML TKIT163A
	GOUTTIÈRE	2 x 2 ml	3 x 2 ml
	CROCHETS	8	12
	CALE DE NIVEAU Leurs orientations permettent la pose à l'horizontale de votre gouttière	8	12
	JONCTION À COLLER * Pour raccorder 2 kits	1 + 1*	2 + 1*
	FOND DROIT FOND GAUCHE	1 1	1 1
	NAISSANCE À COLLER	1	1
	TUYAU	1 x 2 ml	1 x 2 ml
	COUDES À 67°	3	3
	COLLIERS	2	2
	BANDES PROTÈGE PLUIE Facilite l'écoulement des eaux de la toiture dans la gouttière	2 x 2 ml	3 x 2 ml
	VIS INOX	18	26
	1 TUBE DE COLLE	 1 NOTICE DE POSE	

OUTILLAGE NECESSAIRE NON FOURNI	cutter 	 metre ruban	1 cordeau
	cruciforme 		niveau
	crayon 		scie à métaux

KITS GOUTTIERES POUR ABRIS DE JARDINS

. 4ml (Réf. TKIT 162G)

. 6ml (Réf. TKIT 163A)

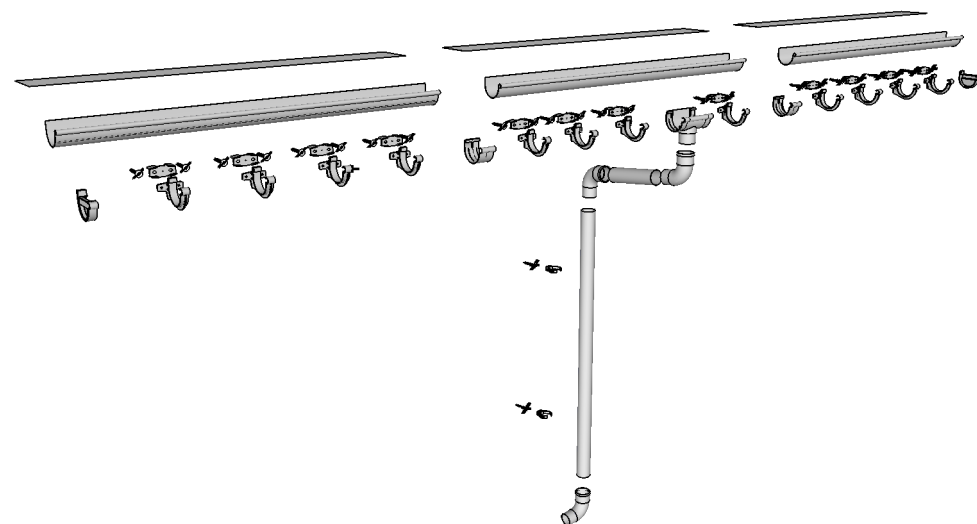

Les kits gouttières
Réf. TKIT162G et Réf. TKIT163A
sont aboutables
Accessoires de jonction inclus

NOTICE DE POSE KITS GOUTTIERES POUR ABRIS DE JARDINS

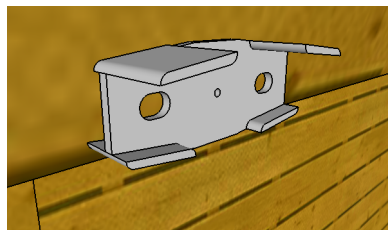

1 ORIENTER LA CALE DE NIVEAU
AFIN DE POSITIONNER LA GOUTTIERE
A L'HORIZONTALE DU SOL
(4 angles d'inclinaison)

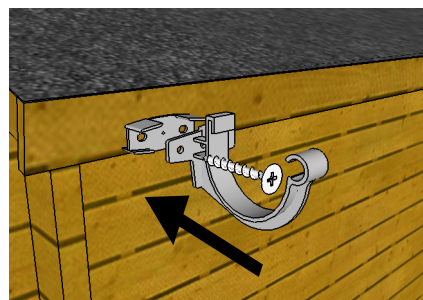

2 VISSER LE PREMIER ENSEMBLE
CROCHET ET CALE DE NIVEAU

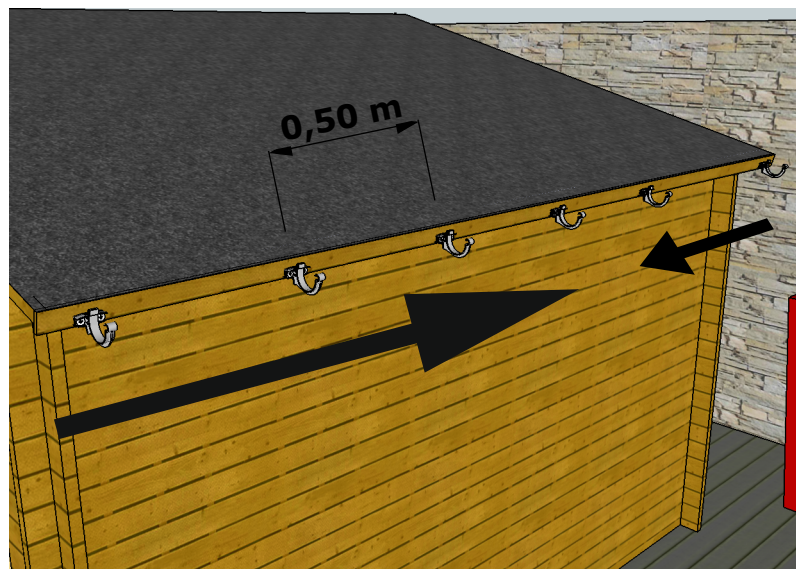

3 ALIGNER ENSUITE LES CROCHETS ET CALES DE NIVEAU TOUS LES
50 CM EN RESPECTANT UNE PENTE D'ENVIRON 1 cm AU METRE. LE POINT
HAUT ETANT TOUJOURS A L'OPPOSE DU TUYAU
D'EVACUATION DES EAUX PLUVIALES

TKIT162G TKIT163A

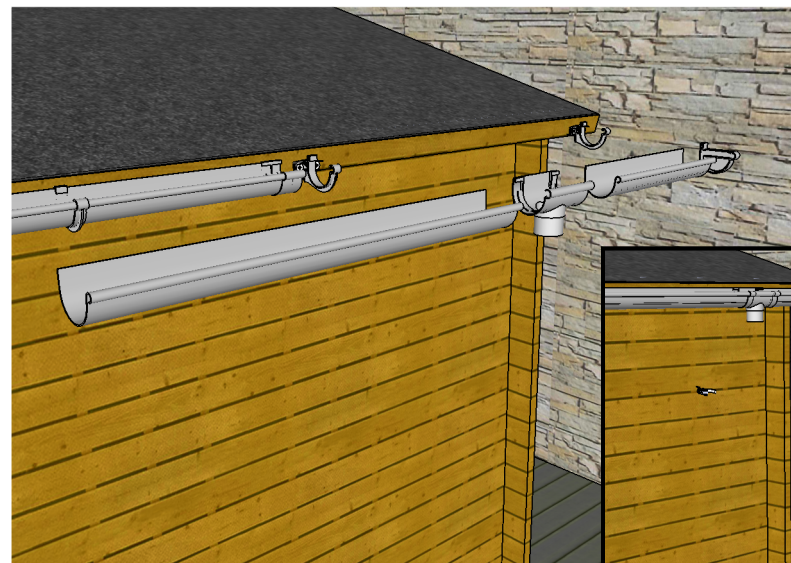

4 COLLER ET INSTALLER LA GOUTTIERE
ET LE TUYAU DE DESCENTE AVEC
TOUS LEURS ACCESSOIRES.
CLIPPER LE TUYAU DE DESCENTE DANS LES
COLLIERS

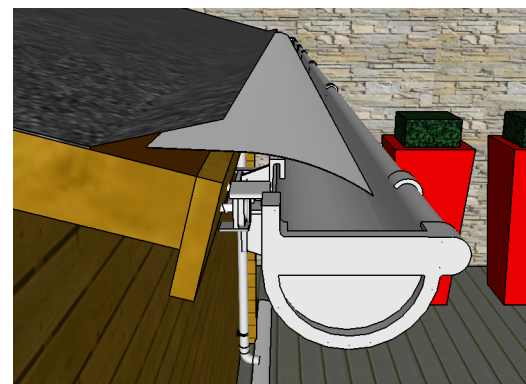
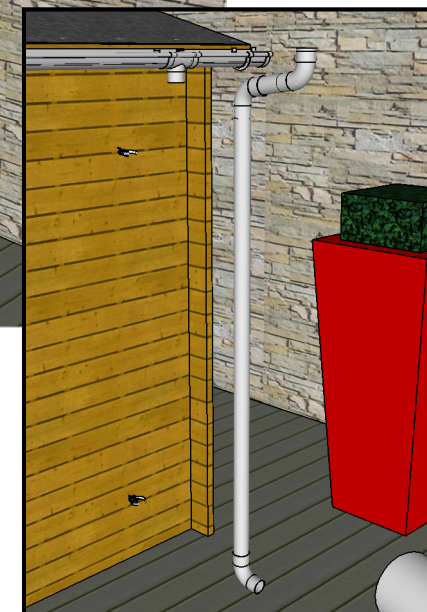

5 METTRE EN PLACE LA BANDE PROTEGE PLUIE
EN SOULEVANT LEGEREMENT VOTRE REVETEMENT
DE TOITURE. FIXER TOUS LES 50 cm MAXIMUM A
L'AIDE D'AGRAFES OU DE VIS (NON FOURNIES)